



BALI

Bali is high performance architectural spotlight with modern design, precise optics provide excellent lighting distribution while minimizing glare, available in various sizes, wattages and optics to meet the needs of most challenging illumination situations, the solid structure can withstand harsh outdoor weather, the luminaire can adapt to many applications with various mounting options, optional anti-glare shield to provide visual comfort, choice of static white colour temperature or RGBW, made of high-grade die cast aluminium and treated with special corrosion resistant powder coat paint, customized solutions available upon request.

Material- High pressure die-cast aluminium housing with high corrosion resistance.

Glass- Tempered glass diffuser

Efficacy- 87-98lm/W for white, 40-49lm/W for RGBW

Finish- Grey powder coated paint

Input voltage- 24V DC or 100-277V AC

Dimming- Dali, 0-10V, DMX

Life: 50,000 Hours L80 B10





Model number: BA-A-20W-30-3K-U-X-S
Wattage for single static white: A-10W 20W 45W 60W 75W 100W 120W 150W
Optics: 2.5° 3.5° 10° 20° 30° 45° 60° 5°x20° 10x70°
Wattage for RGBW: B-10W 30W 60W 100W 150W 200W
Optics: 2.5° 3.5° 10° 20° 30° 45° 60° 5°x20° 10x70°
CCT: 2700K 3000K 4000K 5000K 6000K RGBW
Mounting brackets: F U Z L M H S
Accessories: A-Anti-glare shield H-Honeycomb louvre M-Meshed grill G-Honeycomb glass
Controls: S-Standard D-Dali A-0-10V DM-DMX

Mounting Options



U



M



Z

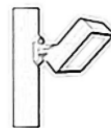

L

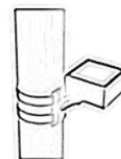

H



F



S

Pole Mount



Pole Clamp

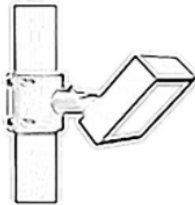

U Bracket



Base Plate



Tree/Pole strap

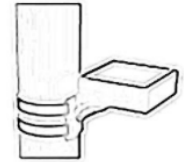

Dimensions

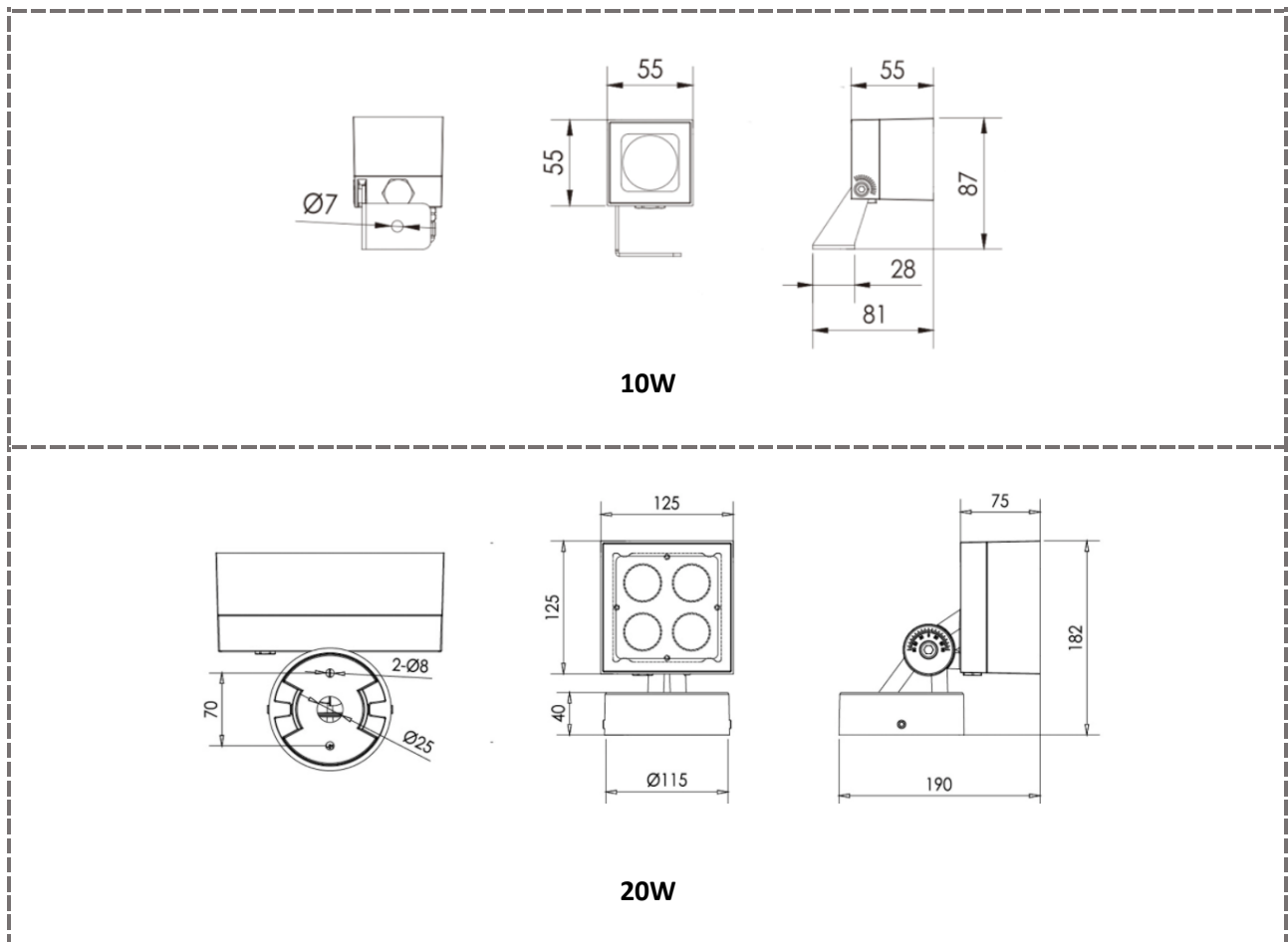

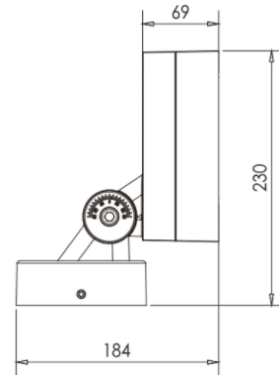
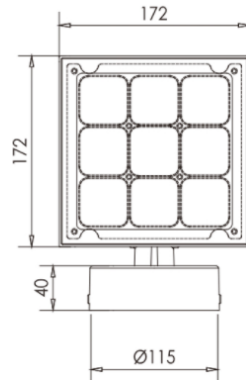
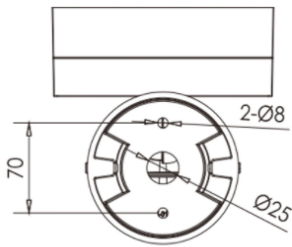

45W & 60W

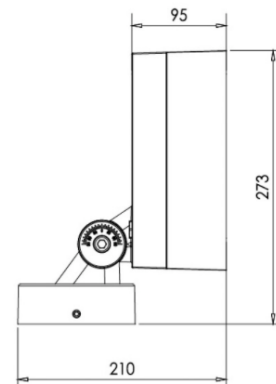
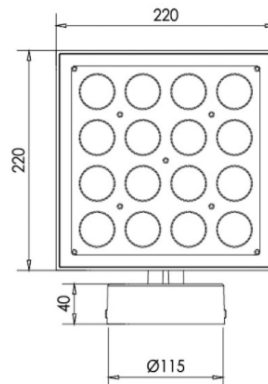
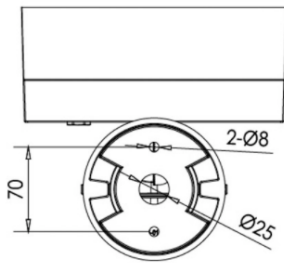

75W & 100W

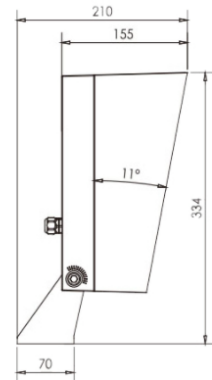
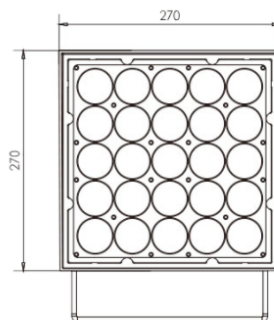
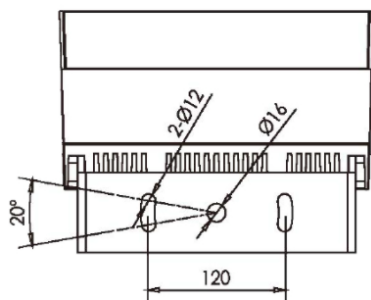

120W & 150W